

Note: All dimensions are approximate and subject to change.

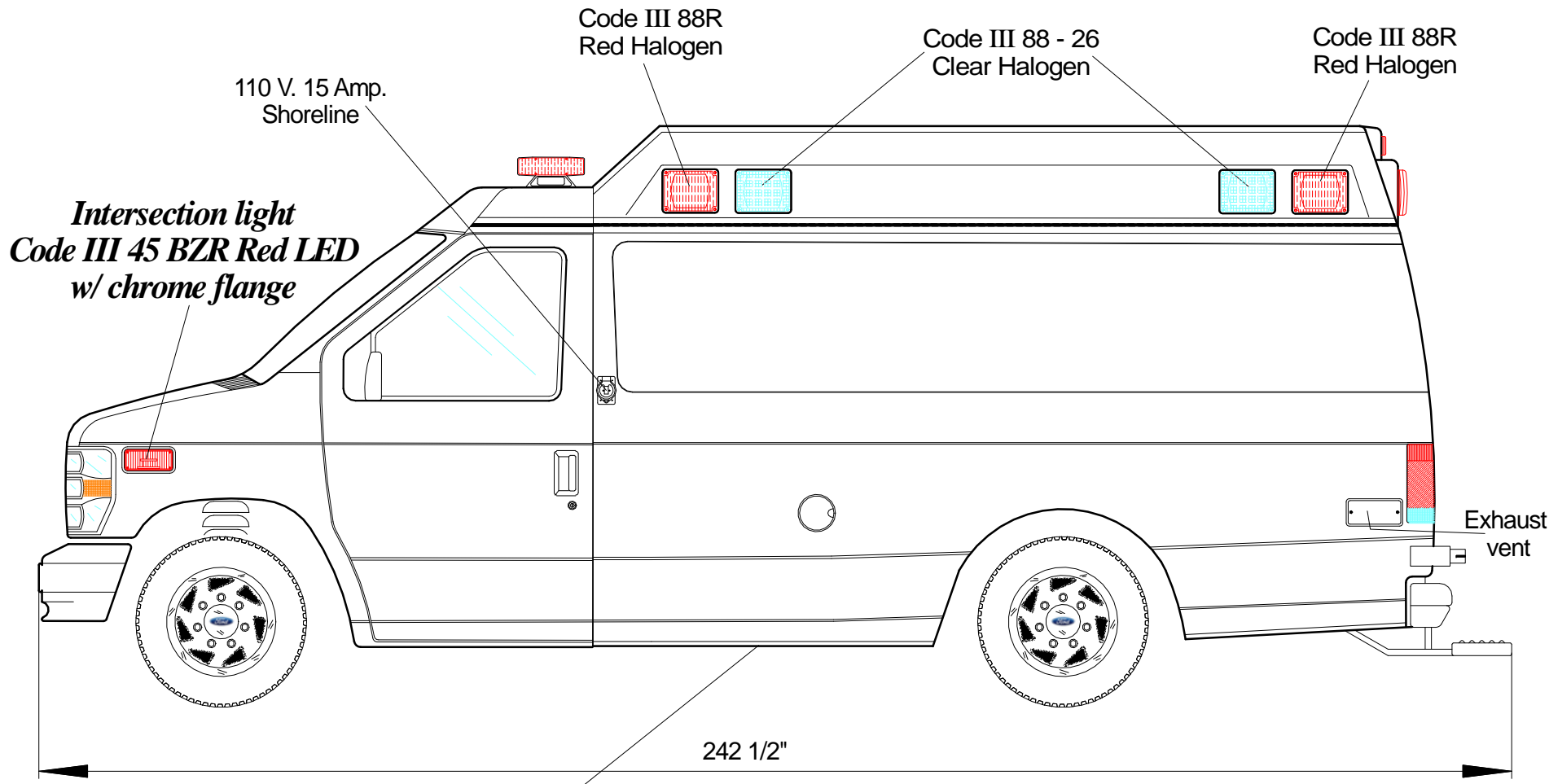

NO BATTERY BOX

Note: All dimensions are approximate and subject to change.

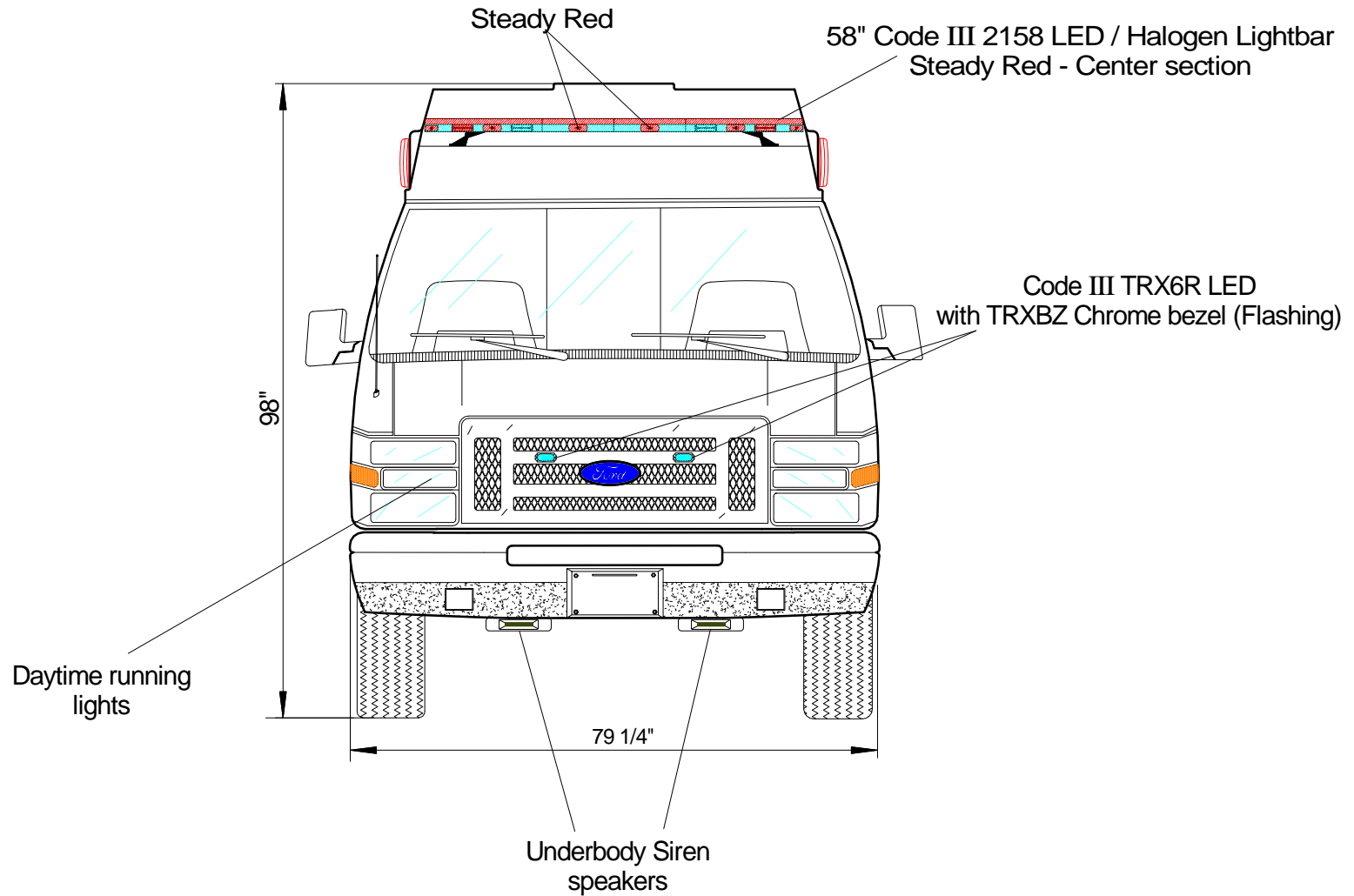

Note: All dimensions are approximate and subject to change.

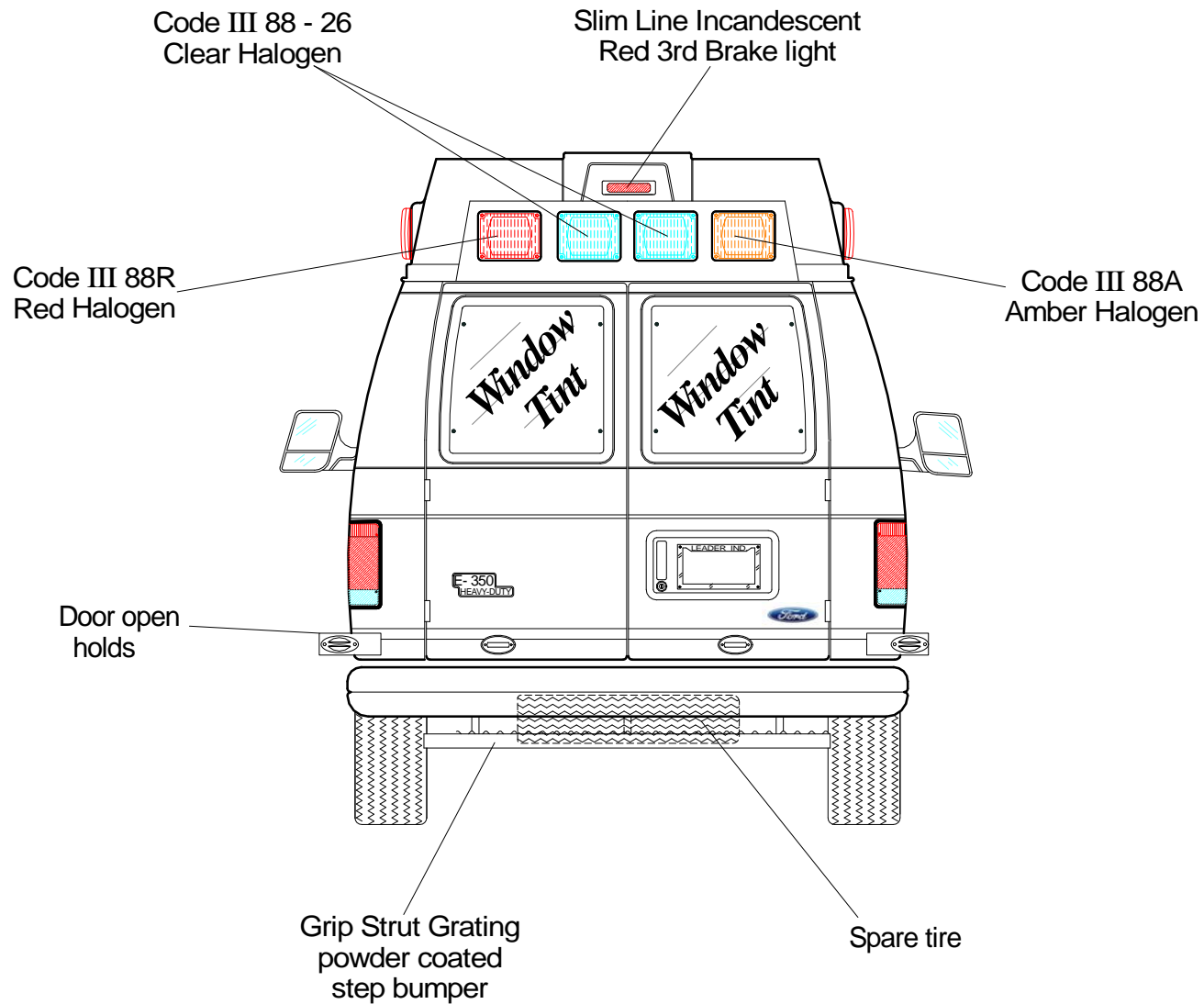

Note: All dimensions are approximate and subject to change.

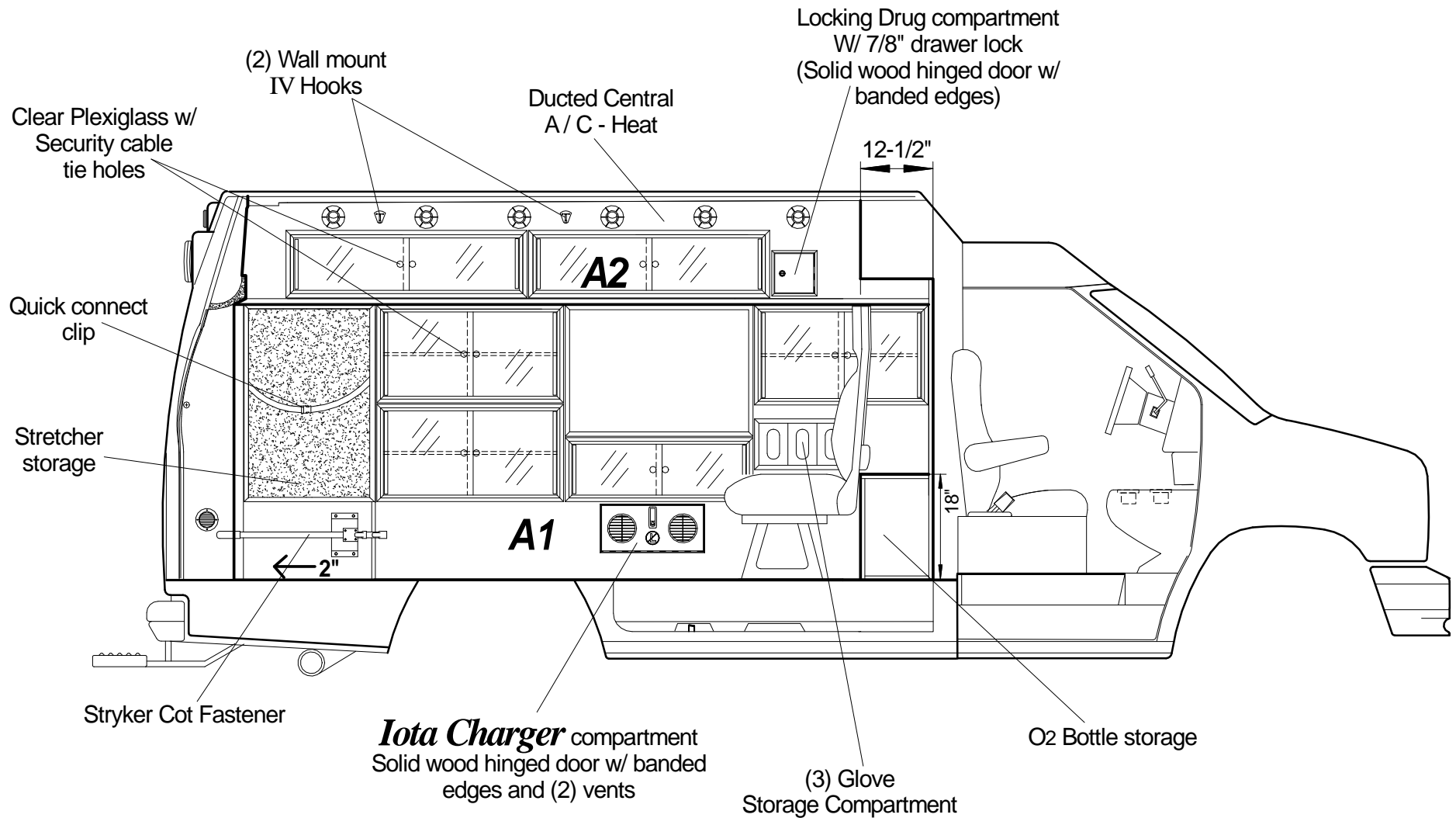

NOTE:

**Re-Position Cot Fastener
2" Towards rear. ILOS**

Note: All dimensions are approximate and subject to change.

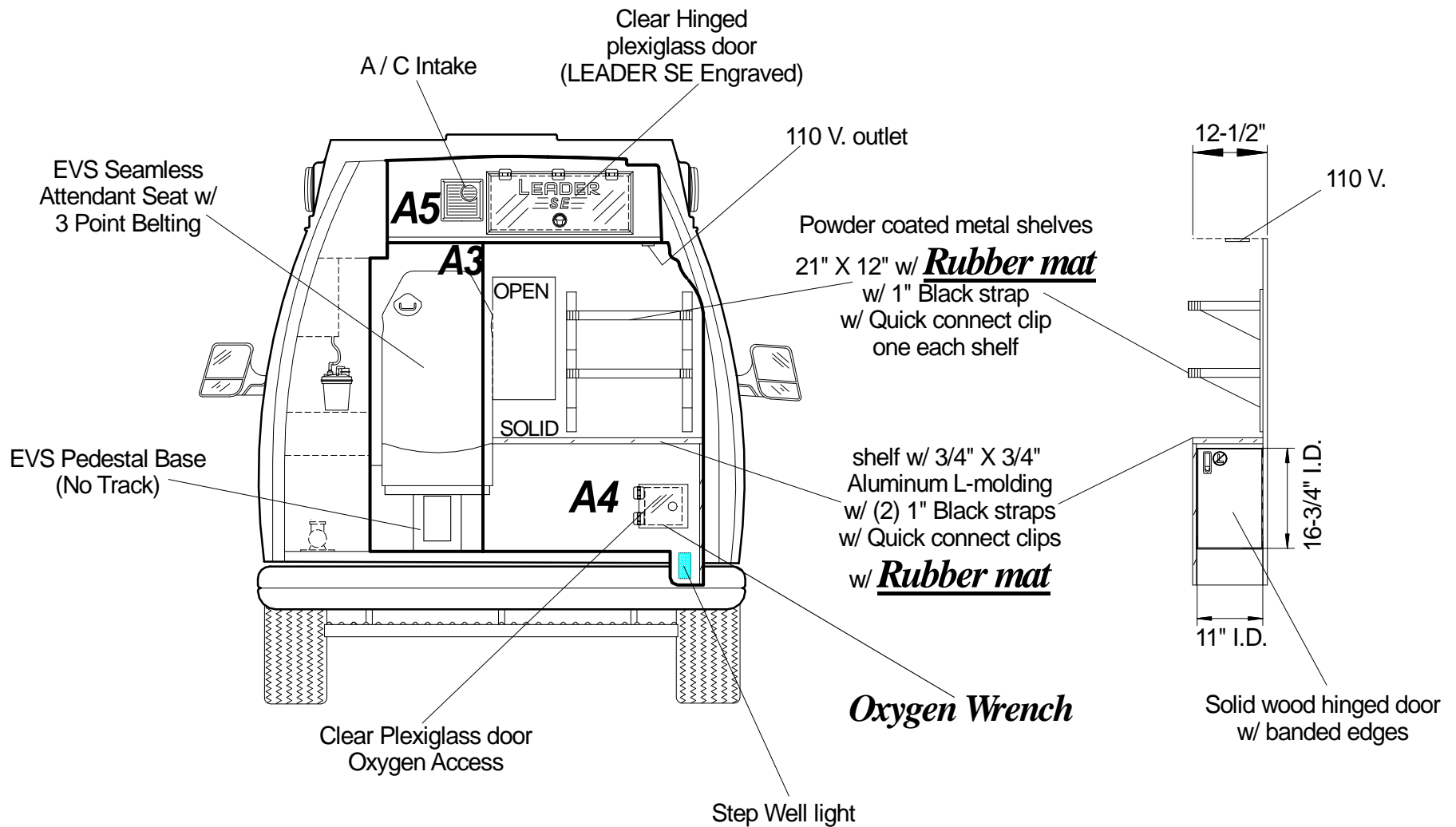

Note: All dimensions are approximate and subject to change.

Cargo Net (Black)
NOTE: Plexiglass Lid
must clear Net

Restocking light
timer 5 min.
Controls (3) domes
over cot (High)

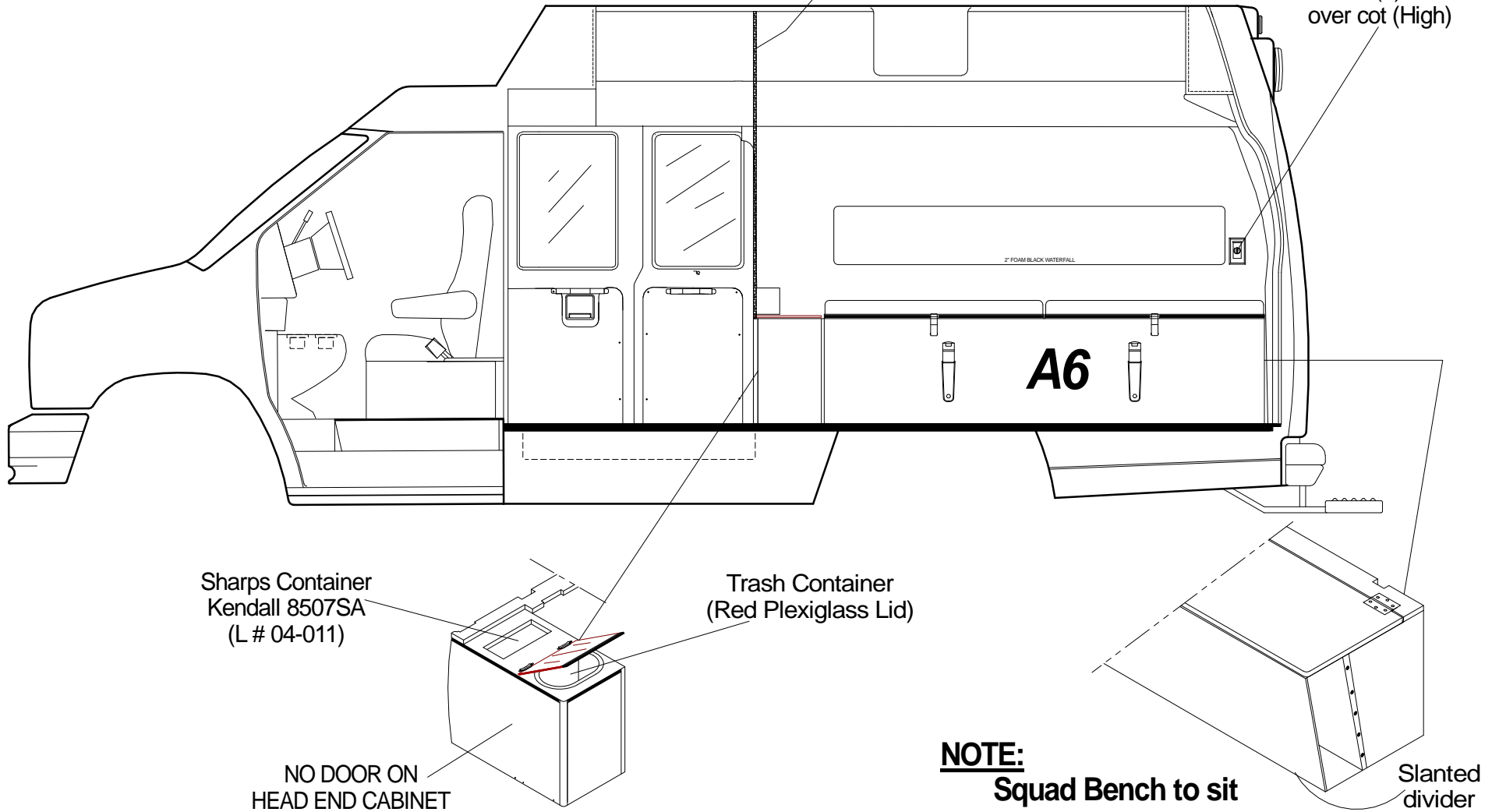

Sharps Container
Kendall 8507SA
(L # 04-011)

Trash Container
(Red Plexiglass Lid)

NO DOOR ON
HEAD END CABINET

NOTE:
Squad Bench to sit
on top of floor

Slanted
divider

Note: All dimensions are approximate and subject to change.

Head bumper

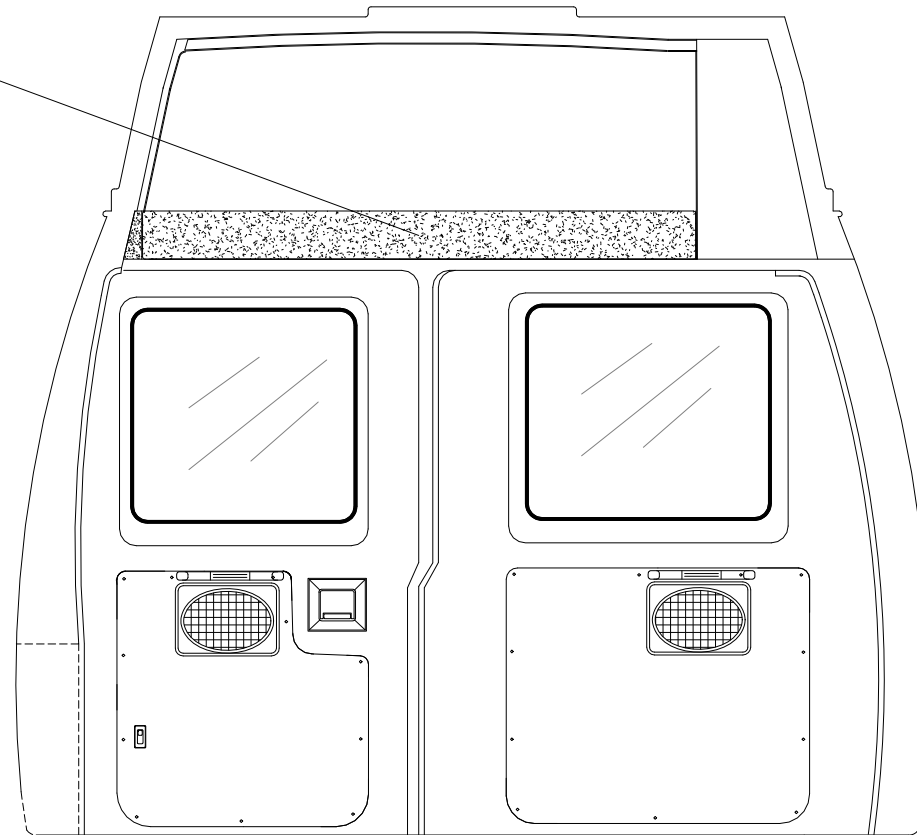

Note: All dimensions are approximate and subject to change.

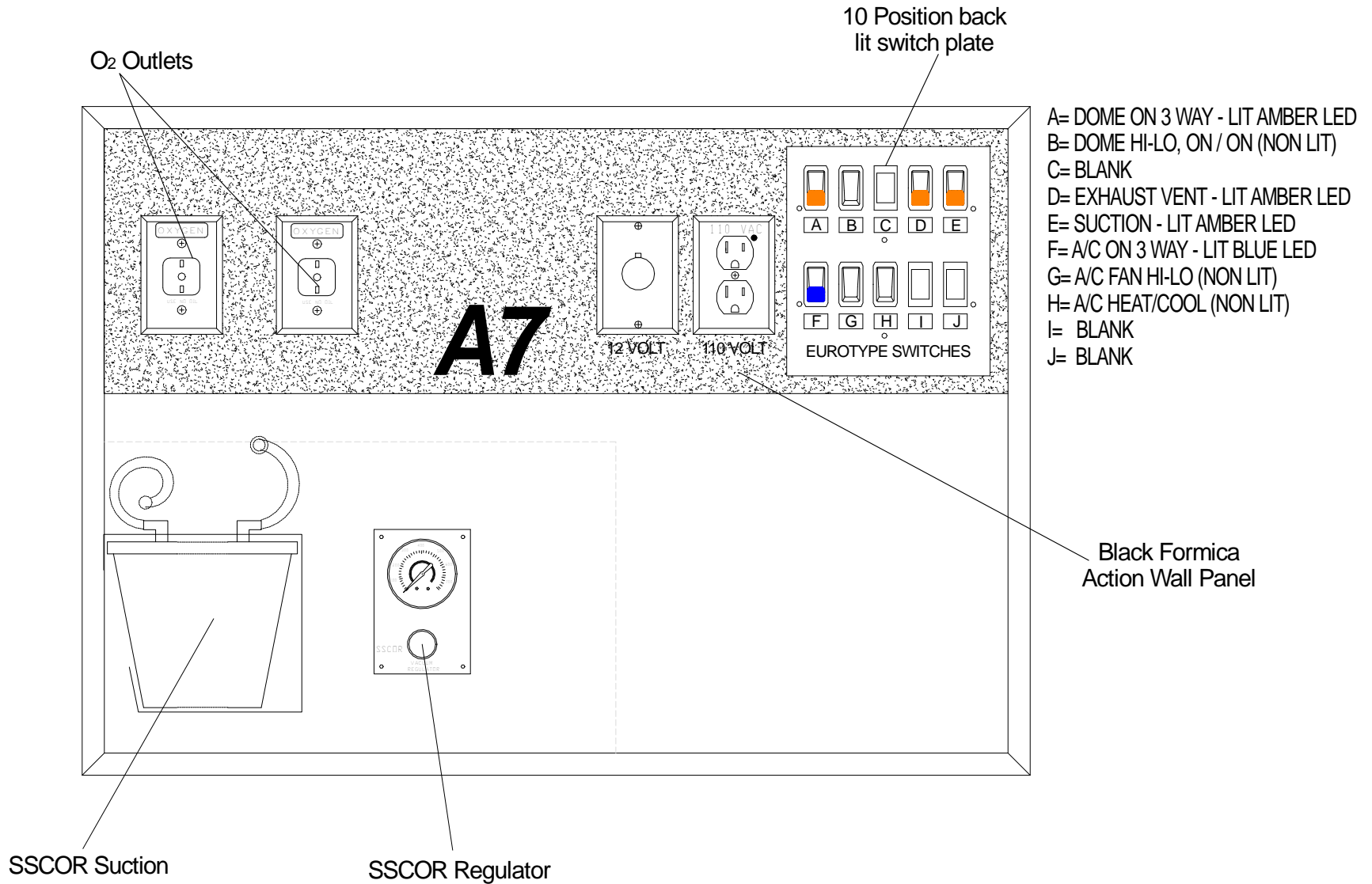

Note: All dimensions are approximate and subject to change.

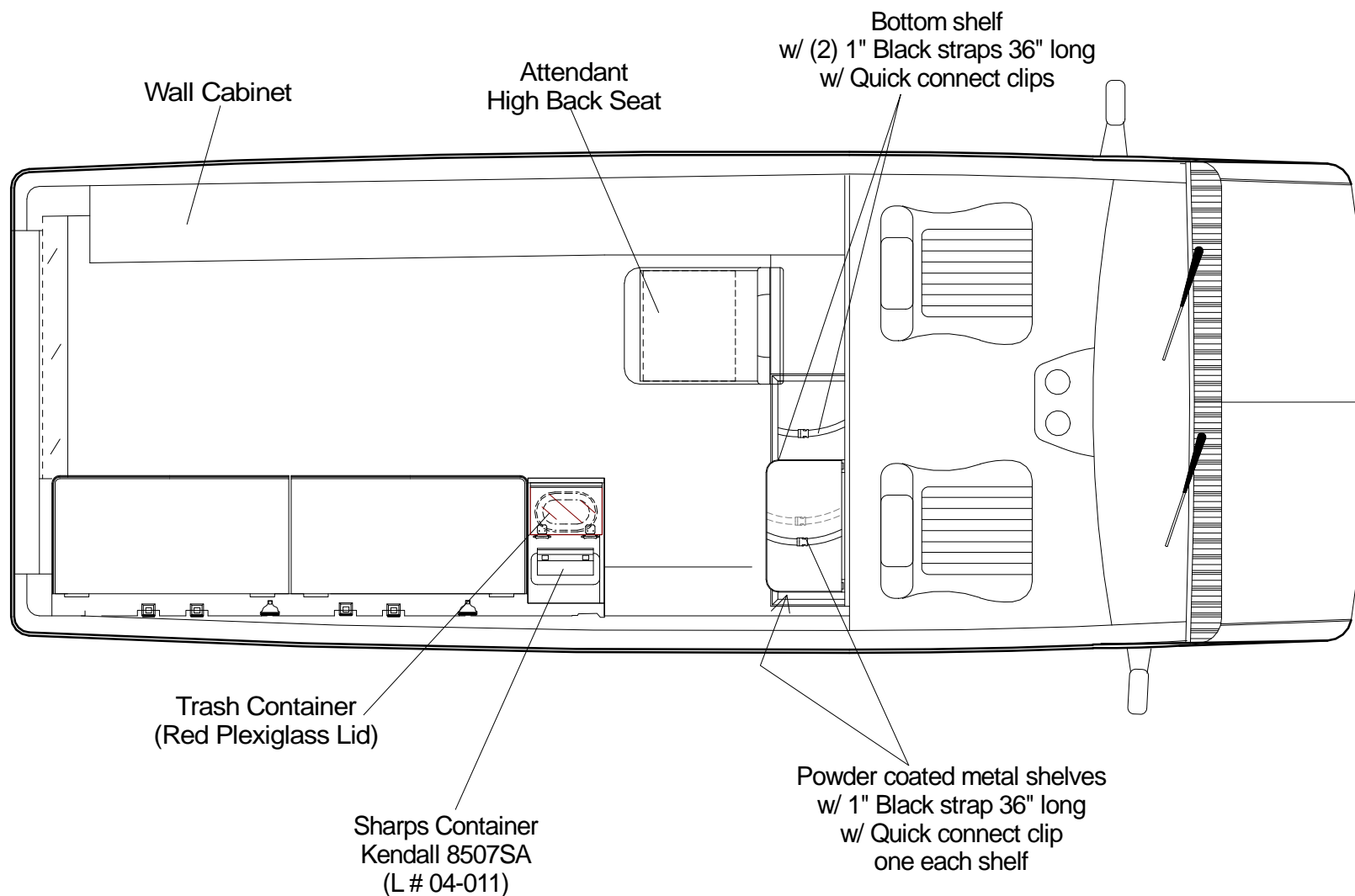

Note: All dimensions are approximate and subject to change.

NO CEILING IV HOOKS

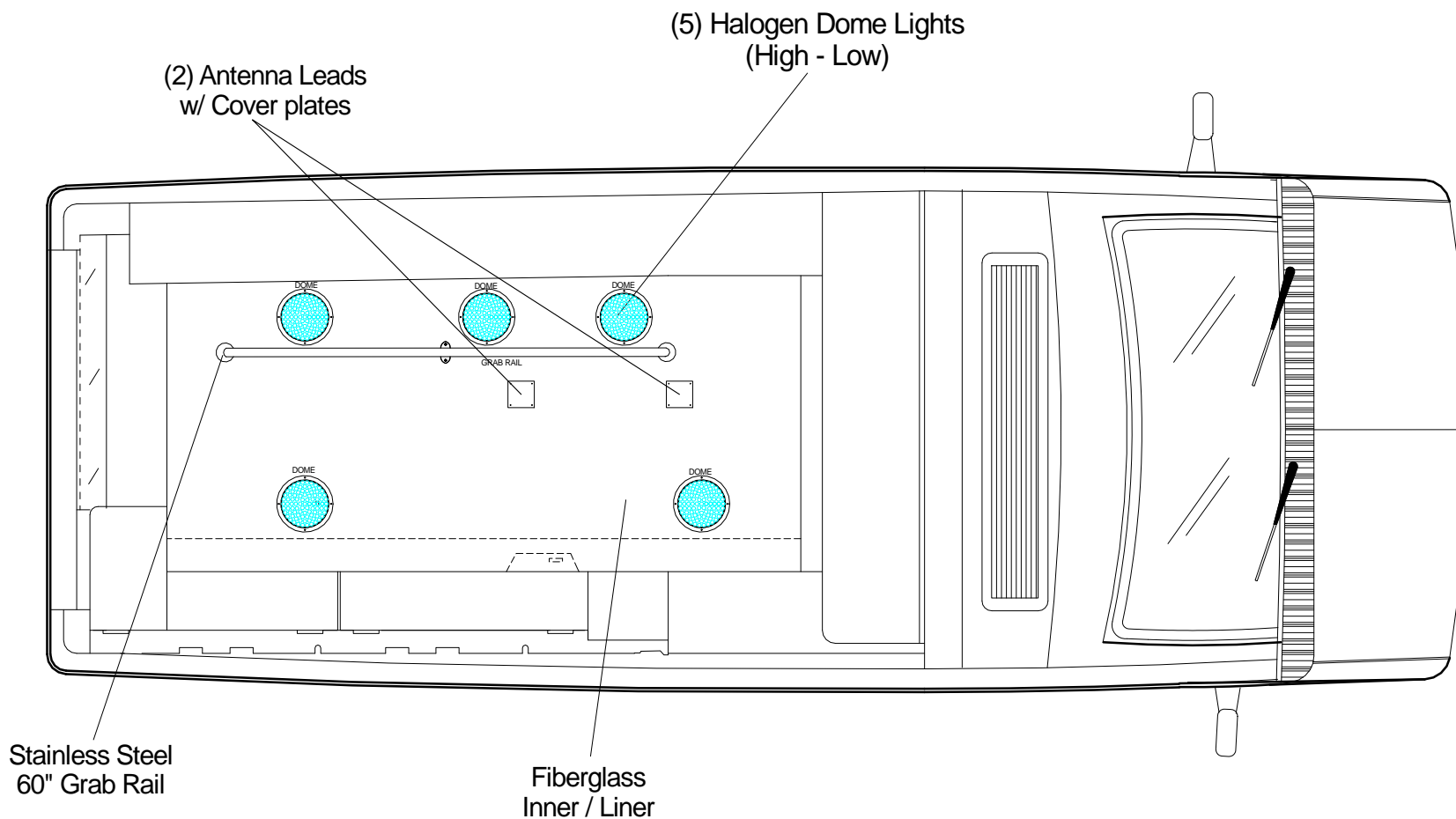

Note: All dimensions are approximate and subject to change.

- A-PRI-SEC RED AMBER, ON-OFF-ON - LIT RED/AMBER LED
(PRI) ALL EMERGENCY LIGHTS INCLUDING REAR.
(SEC) REAR AMBER / RED HALOGEN ONLY.
- B-BLANK
- C-BLANK
- D-BLANK
- E-BLANK
- F-BACK UP ALARM-RESET TYPE-MOMENTARY ON (NON LIT)
- G-LEFT SCENE - LIT WHITE LED
- H-REAR SCENE - LIT WHITE LED
- I -RIGHT SCENE - LIT WHITE LED
- J- 3 WAY PATIENT DOME, ON-ON - LIT AMBER LED
- K- 3 WAY PATIENT A/C, ON-ON - LIT BLUE LED
- L- BLANK.
- M- MOD. DISCONNECT - LIT GREEN LED
- N- BLANK

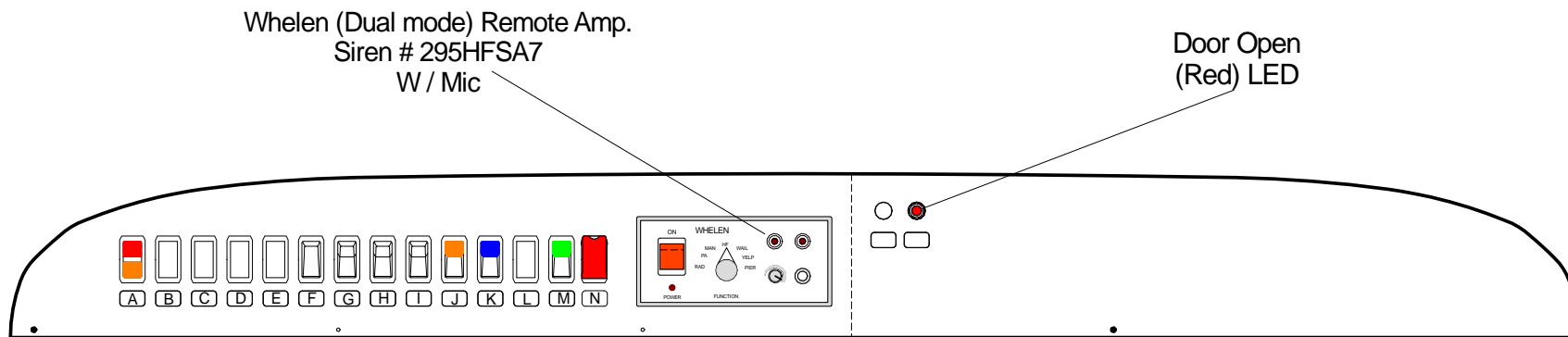

Note: All dimensions are approximate and subject to change.

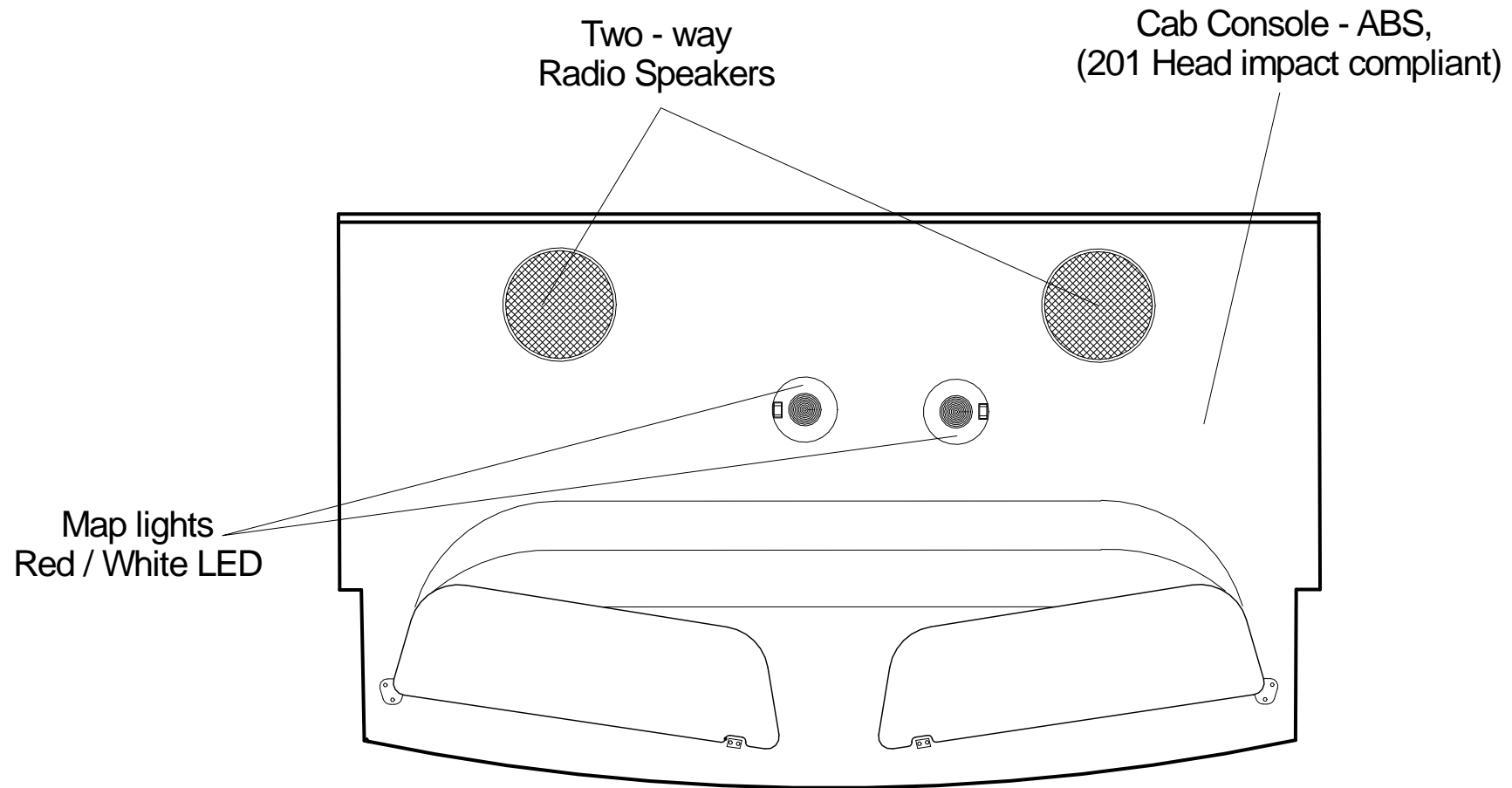

Note: All dimensions are approximate and subject to change.